

Article number: 12747000060110

Description: KLEE-coil 747 000 060.110  
M6 Steel, zinc-pl. & chr. blue

## Measures

---

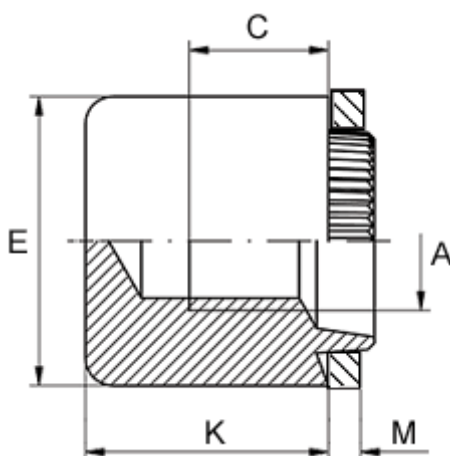

Female thread A	= M6
Height K	= 11.0
Min thread length C	= 6.0
Outer diameter E	= 13.0
Plate thickness	= 1.7 to 1.9
Recommended bore diameter for extreme load	= 10.0
Recommended bore diameter for normal use	= 10.0